

# DR. ROBERT

USER MANUAL &  
SAFETY INSTRUCTIONS



Thank you for purchasing the Dr. Robert!  
The most accurate replica of the legendary **Vox® UL730 amplifier!**

**aclam**

[www.aclamguitars.com](http://www.aclamguitars.com)

C/ Consell de Cent, 201 - local  
08011 Barcelona. Spain  
Llevinac S.L.  
CIF: B64412406

## Index

Overview	4
Features	6
Specs & material Included	9
Powering Requirements	10
Operating Diagram	12
Controls	13
Advanced Internal Controls	18
Setting examples	20
Setting up on a pedalboard	24
Trouble Shooting	27
Security Instructions	28
Warranty Terms	29
Your own settings	30

## Overview

The Vox® UL700 amp series were the secret weapon used by **The Beatles** to achieve the unique guitar tone on **Revolver** and part of **Sgt. Peppers**. They were also used by The Rolling Stones and Jimmy Page of Led Zeppelin.

Introduced in 1966 these state-of-the-art guitar amps mixed a solid-state preamp with a tube power amp section.

Tubes were standard at that time but had the inconvenience of being voluminous and prone to fail, plus they needed bigger transformers due to impedance matching and power requirements. Transistors were the solution as they were way smaller, reliable and took much less energy to operate. So, in 1965, Vox engineer Dick Denney decided to develop a **hybrid amp** with a solid-state preamp and tube powered amp section.

Thanks to the relatively new transistor technology, lots of features could be added.

Top of the line models included two channels with three band eq each, distortion, tremolo and reverb.

There were many variants with different power ratings, but the ones used by The Beatles were the **UL730 (30w)** and UL7120 (120w).

Unfortunately, aside from The Beatles, those amps weren't popularly used at the time and most of them ended being returned to Vox for their disposal.

Only a small number of UL730 units survived (around 20/30 units as some renown Vox connoisseurs state), attaining the title of being the most collectable Vox amps, with prohibitively collector pricing.

Now they are the missing link between tube and solid-state amps.

The **Dr. Robert** is based on the Normal channel of our **Vox® UL730 S/N: 3042**. We traced the original tag board circuits and measured each component's value to make the closest replica of the amp's soul and character.

One of the keys of its tone is the **"Mids"** control which is one of the most interesting mid-range eq ever found on an amp. By turning it counterclockwise, a great amount of mid-frequencies will be subtracted creating a scooped sound. On the other hand, when it's turned clockwise it will bring out all the mids and the signal will build up in gain. By tailoring the "Mids" knob you can control both midrange and saturation.

As the solid-state preamp of the UL730 doesn't create much distortion by itself we've coupled it with a **custom FET saturation** engine to mimic the attributes of the **tube power amp section**. Not happy with that, we've gone even further creating the **"Mach Schau!"** section, which adds saturation to your main sound and includes an independent volume control to allow you to have both a rhythmic and a solo tone.

Disponible en otros idiomas en:  
[www.aclamguitars.com](http://www.aclamguitars.com)

Available in other languages at:  
[www.aclamguitars.com](http://www.aclamguitars.com)

# Features

## **THE MOST ACCURATE REPLICA OF THE ORIGINAL UL730 PREAMP:**

Sometimes you can't trust the internet or an old schematic! We've found major discrepancies between the published schematic and the real thing, such as component types and values, so we can assure this is the closest you can get to the rarest Vox amp!

Following the preamp there's a custom FET based circuit emulating the saturation produced by the UL730 EL84's tube power amp section.

Additionally, the circuit works with the same voltages found on the original amp thanks to a charge pump circuit which takes the 9VDC from the battery or DC plug and converts it to 18VDC.

## **CUSTOM GRAPHICS BY REVOLVER'S COVER ARTIST, KLAUS VOORMANN:**

We're so honored to have Mr. Klaus Voormann, designer of The Beatle's Revolver album cover, sign the artwork for the Dr. Robert!

## **MACH SCHAU! FUNCTION:**

Extra saturation function via a footswitch with an independent volume control. Hit it when the venue's manager wants you to play harder!

## **SMART TRACK® FASTENING SYSTEM:**

All our pedals use a custom enclosure designed to perfectly match perfectly our Smart Track® pedalboards. Using the side thumb screws, you'll be able to lock safely the stompbox into one of our pedalboards. It also was designed with the other pedalboard options in the market in mind. (see page 22)

## **CIRCUIT TAILORED FOR BOTH GUITAR & BASS INSTRUMENTS:**

Although based on the UL730 preamp, the UL400 series (designed for bass) shared almost the same circuitry. When doing tests using different instruments and amps we noticed the Dr. Robert sounded flawless with bass too!

By tuning the FET circuit a bit, we managed to make the Dr. Robert suitable for both guitar and bass. No low-end drops

resulting in a perfect preamp and distortion tool to plug directly to the desk or into an amp.

## **SAME 3 BAND EQUALIZER VIA INTERNAL TREBLE AND BASS TRIM CONTROLS:**

The Mids control is a unique feature to shape the particular sound of the Dr. Robert pedal. But we didn't want to let you down in terms of tone shaping so the Bass and Treble controls found on the original VOX UL730 are on the inside of the pedal!

## **HIGH END COMPONENTS:**

We made an extra effort to put the finest and closest components to the original amp on the Dr. Robert. Carbon comp resistors, Nichicon Fine Gold and Wima caps, Alpha pots makes the Dr. Robert a reliable pedal with a superb tone.

## **TRUE BYPASS RELAY SWITCHING:**

We've designed an intelligent true bypass relay switching system which constantly monitors voltage supply (both

battery or DC jack input) and switches itself to true bypass when it detects a drastic drop in voltage.

This way you'll never get any signal interruption even if your power supply or battery fails.

It also tells you when the battery is close to completely draining by making both the Boost and Bypass LED's (depending on your current setting) blink. So, you have at least 2-3 hours to replace the battery before the pedal goes into self-bypass.

## Specs & Material included

**DR. ROBERT REF:**  
AP0020-2

**DIMENSIONS:**  
13,6 x 8,7 x 5,5cm (5.4" x 3.4" x 2.2") with knobs.

**WEIGHT:**  
410g. (0.90 lbs).

**BYPASS:**  
Relay True Bypass

**POWER REQUIREMENTS:**  
9V DC Center Negative 100mA minimum or a 9V battery

**CURRENT DRAW:**  
≈40mA

**DECLARATION OF CONFORMITY:**  
This product complies with the requirements of



**MADE IN SPAIN**

**MATERIAL INCLUDED**  
1 x Dr. Robert pedal  
1 x Anti-sliding rubber pad  
1 x Velcro® pad

# Power requirements

## 9V BATTERY

To operate the Dr. Robert with a 9V battery you'll have to follow the next steps:

- 1 Loosen the side thumb screws and disassemble the Smart Track<sup>®</sup> system of both sides of the pedal.

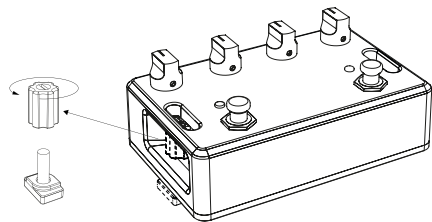

- 2 Unscrew the four bolts of the baseplate using a pozidriv screwdriver to access the inside of the pedal.

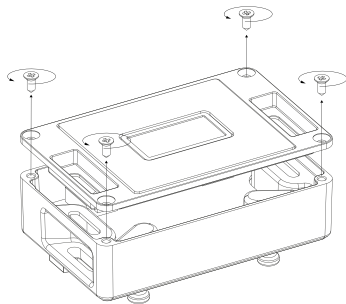

- 3 Put the 9V battery in the position showed in the diagram. Make sure to use a good quality alkaline battery to ensure the longest time of operation.

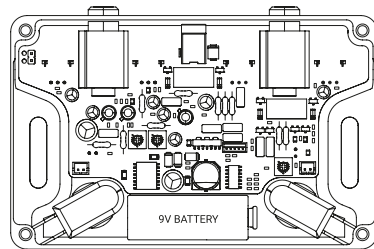

- 4 Tight back the lid with the 4 screws and reassembly the Smart Track<sup>®</sup> system.



## CAUTION:

If used improperly, batteries may explode or leak and cause damage or injury.

- The use of an incorrect type of battery can void the safeguard mechanisms of the device (for example, in the case of some lithium battery types)
- Batteries must never be recharged, heated, taken apart, or thrown into fire or water.
- Do not expose the unit to extremely high temperatures, direct sunlight or other devices that radiate heat, as it may lead to an explosion or leakage of flammable liquid or gas.

## POWER SUPPLY

This unit can be powered with a 9VDC negative tip power supply with the standard Boss type 2.1mm connector.

Current supply should be a minimum of 100 mA just to leave a safety margin for the DC adapter.

Make sure you use a good quality power supply and avoid using generic SMPS type adapter which can induce high pitched noise to the audio.

## Operating Diagram

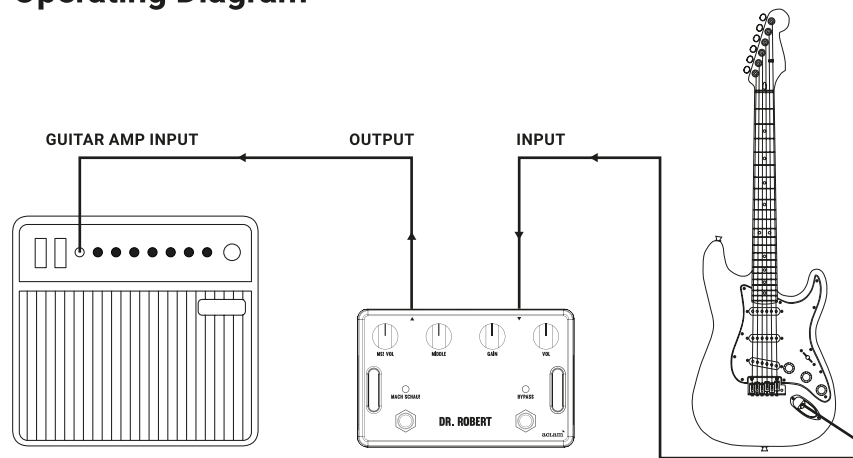

## Controls

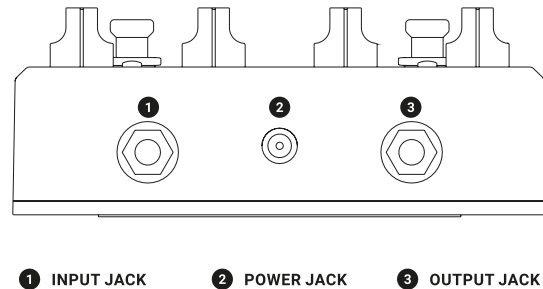

- 4 **BYPASS SWITCH:** Engages the unit allowing the signal to flow through the Dr. Robert circuit. It also lights up the LED above it.
- 5 **VOL:** Controls the overall volume of the Dr. Robert when you're not using the Mach Schau! section.
- 6 **GAIN:** This control is placed in the same position of the circuit as the original UL730's volume control. Since none of the Vox® UL series had a master volume control the user had to turn it all the way up to bring the amp into saturation, and believe us, this thing is loud. To solve that we put the Vol control at the end of the FET section so now, the volume control on the original amp turns into a gain knob on the Dr. Robert.

At lower settings the Gain knob will produce a clean tone, but as you approach the 12'o-clock mark the FET section will start entering the saturation region.

**Have in mind that due to Dr. Robert's great dynamics, different types of guitars and pickups will affect the clean range of the Gain knob.**

- 7 **MIDS:** This is the most critical knob to tailor your sound. Unlike most equalizer circuits (which get placed after or before the volume control) Vox® separated the mids control from the rest of the tone stack in the UL730. In this preamp the signal gets amplified first, followed by the Mids control before the volume pot. After this, Vox® placed a special gain stage coupled with the Bass and Treble controls. Thus, you can control the midrange without interacting with the rest of the eq, as traditional tone stacks do.

By turning it counterclockwise, it will subtract a great amount of mid-range, creating a really interesting scooped sound.

Turning it clockwise will bring mid frequencies and the overall gain builds up hitting harder the EL84 tubes, creating saturation.

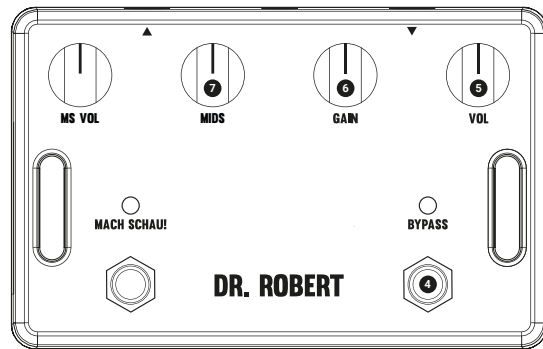

Just like the real amp does, Dr. Robert's "Mids" control has the same behavior thanks to the FET section specially tuned to mimic the power amp saturation on the UL730.

So, keep in mind, the "Mids" knob will have a great effect on the overall saturation of the unit.



## THE MACH SCHAU! SECTION

The Mach Schau! section was conceived during the design process of the Dr. Robert to make it more versatile in live scenarios. Every now and then, you need an extra push in terms of gain, to play solo parts or for songs you want people to shake their waist at.

Taking The Beatles "She Said She Said" cut for example, there's a lead part, clearly saturated and the main rhythmic arpeggio in a cleaner tone. With the Dr. Robert you could play both tones using the Mach Schau! section for the lead parts.

The Mach Schau! extra saturation will always be determined by the Gain and Mids knob settings, meaning that the heavier your main setting is, the grittier this section will build up from. Paired with the extra gain circuit there's an independent volume control labelled "MS VOL" to allow you a better control of this section. Easy and simple :)

- 8 **MACH SCHAU! SWITCH:** Activates the Mach Schau! Section. It also lights up the LED above it.

(Note that the Mach Schau! function works only when the Dr. Robert's bypass switch is activated. This function is not an independent overdrive but an extra tone of Dr. Robert's main circuit)

- 9 **MS VOL:** Independent volume control for the Mach Schau! section.

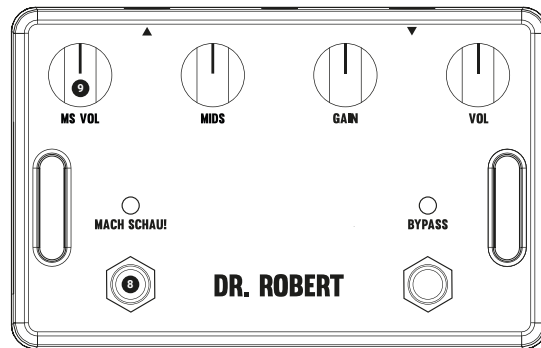

# Advanced Internal Controls

The original UL730 had a 3 band eq, but since the Middle control is the one that helps to tailor the tone better we decided to put the Bass and Treble controls inside the pedal. Just to make the user interface cleaner and easier to operate.

## HOW TO ACCESS THE INTERNAL CONTROLS:

Just follow the same steps described on the 9V battery replacement instructions. To adjust the internal controls, grab a small flat screwdriver :)

- 1 BASS:** Sets the amount of low frequency content reaching the FET section. The Treble and Bass controls work together in a tone-stacked manner, so they are a bit interactive.

Both controls are factory set at 12 o'clock.

- 2 TREBLE:** Controls the amount of high frequency content of the signal before reaching the FET section. Setting this knob will have an effect over the overall gain.
- 3 MACH SCHAU! GAIN TRIM** We have included a Gain trim for the Mach Schau! section. This will allow you to lower the saturation and make it a little bit less aggressive. At high gain settings it's less effective but a lower gain it will make the Mach Schau! sound a bit gentler. Try it and experiment!

Factory setting is fully clockwise (max gain)

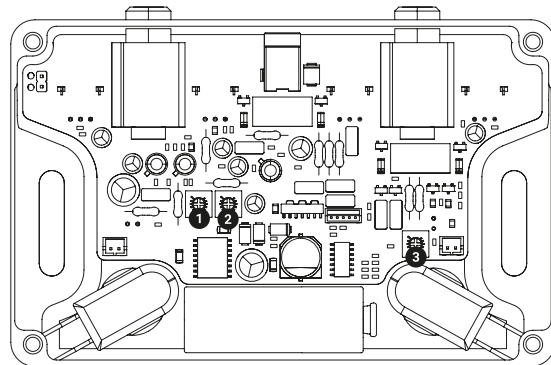

**1 BASS**    **2 TREBLE**    **3 MACH SCHAU! GAIN TRIM**

# Setting Examples

To show you the immense potential of the Dr. Robert, we recommend you trying the following setting examples. Bear in mind the Vox® UL730 is a British amp so we noticed a certain preference of the Dr. Robert to amps powered with EL84 and EL34 tubes.

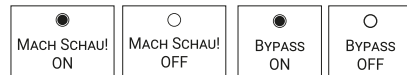

These examples were fine-tuned with different guitars (mentioned on each diagram) and a Doctor Z Maz 18 amp.

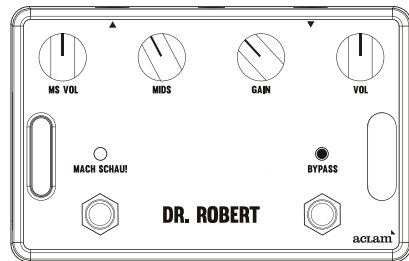

**PAPERBACK WRITER (LEAD GUITAR)**  
Epiphone Casino & Gretsch 7120

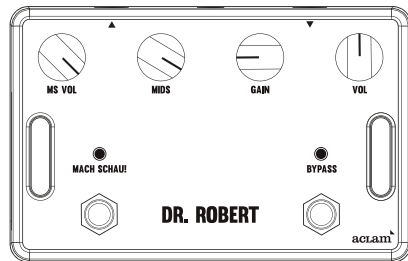

**SHE SAID SHE SAID**  
Epiphone Casino & Gibson SG (with Maestro Vibrola)

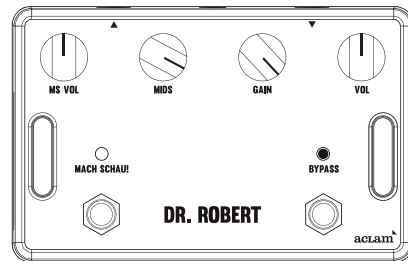

**RAIN**  
Epiphone Casino

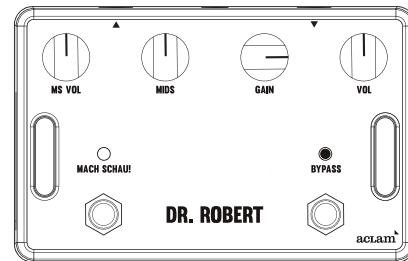

**DR. ROBERT**  
Epiphone Casino

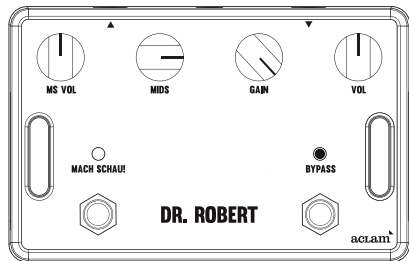

**TAXMAN**  
Fender Stratocaster

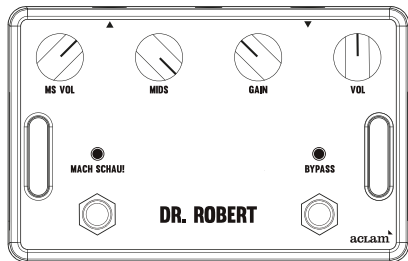

**TAXMAN (SOLO)**  
Fender Stratocaster

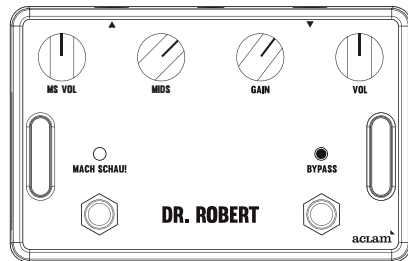

**SGT. PEPPER'S (RHYTHM)**  
Epiphone Casino

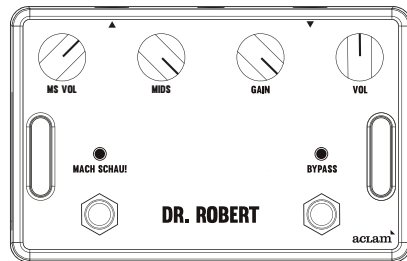

**SGT. PEPPER'S (LEAD GUITAR)**  
Epiphone Casino & Fender Stratocaster

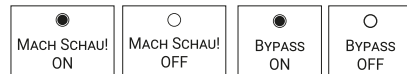

## Setting up on a pedalboard

All our effect pedals use a custom light aluminum enclosure specially designed to fit our Smart Track® pedalboards. We incorporated a proprietary locking system which allows the user to fasten the pedal without the need of using the typical hook and loop method. This custom fastening system follows the same philosophy behind the Smart Track® fasteners but integrated in the enclosure reducing the space occupied by each pedal.

That translates into more pedal density for the same space, and who doesn't want that?

We strongly recommend you to take a look at our line of pedalboards, which are the best complement to our pedals!

### HOW TO MOUNT IT ON A SMART TRACK® PEDALBOARD:

- 1 Add the anti-sliding rubber pad at the bottom of your pedal, specially shaped for this unit.  
⚠ Surface must be clean and dry before applying adhesive pad.

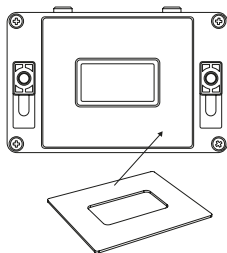

- 2 Loosen the 2 thumb screws to unlock the bottom pieces out of the pedal.
- 3 Place the pedal, inserting the bottom pieces inside the grooves.

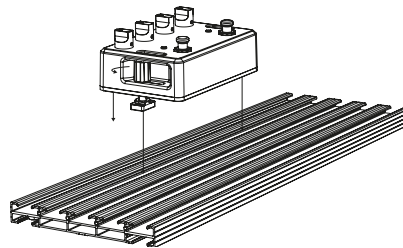

- 4 Move the pedal to its final position.

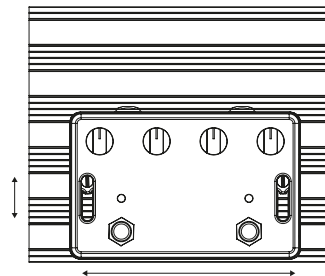

- 5 Tighten the two thumb screws with your hands or with a screwdriver.

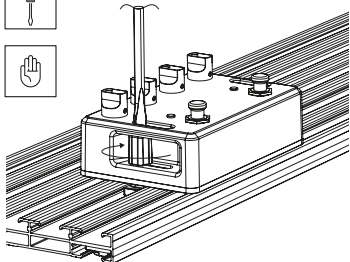

#### USING OTHER PEDALBOARDS:

Hook and Loop: Take the included super strong Velcro® pad and stick it on the base plate. Again, make sure the base is clean of dirt and dust.

Pre-drilled pedalboard: Fix it with a bolt and a nut you could find at any hardware store or instead of passing the zip tie over the pedal you can take advantage of the Smart Track® enclosure and put the zip ties over the holes.

DIY woodboard: You can screw the pedal directly with wood bolts through the enclosure side holes.

No board: If you use the pedals standalone make sure you place the included anti-sliding rubber pad on the baseplate.

## Trouble Shooting

#### SIGNAL PASSES THROUGH IN BYPASS BUT NOT WHEN ENGAGED:

Make sure you've connected the input and output jacks correctly.

#### PEDAL DOES NOT WORK WITH THE POWER SUPPLY:

Take a look at your power supply output voltage and polarity. Make sure it's 9V DC negative tip with a minimum output of 100 mA.

#### PEDAL WON'T ENGAGE WITH BOTH THE POWER SUPPLY AND BATTERY:

Check there's a plug inserted into the Input Jack.

#### PEDAL SOUNDS DISTORTED AT REALLY LOW SETTINGS:

- If you're running on batteries replace it with a new one or check the voltage with a multimeter.

- The Dr. Robert is a really dynamic pedal the same way the original amp is. Different types of guitars and pickups will make it saturate in different regions of the knobs. That is a totally correct response from the unit.

- Make sure there's not any pedal before the Dr. Robert increasing too much the guitar's signal output, like boosters, preamps compressors and other overdrive pedals.

#### THE LEDS ARE BLINKING:

If you're powering your Dr. Robert with a battery replace it with a fresh one. See page 7 for more info.

## Security Instructions

- Read these instructions carefully.
- Keep them for future reference.
- Heed all warnings.
- Aclam Guitars shall not be held liable for any damage to persons or property caused by incorrect operation or installation.
- Use the product in accordance with the assembly instructions. Do not modify or operate the product incorrectly.
- Incorrect installation could result in serious damage to persons and property.

- Open the package and check that the assembly instructions and all the parts of the product are there. Check that none of the parts are defective.
- Keep out of reach of children. This product contains small parts that represent a choking hazard if swallowed.
- If you do not understand these safety instructions, or if you have any queries regarding the safety of the installation, please contact Aclam Guitars: [support@aclam.cat](mailto:support@aclam.cat)
- If you wish to contact Customer Services at Aclam Guitars, please write to [guitars@aclam.cat](mailto:guitars@aclam.cat)

## Warranty Terms

This product is covered by a two-year warranty from the purchase date, under the conditions and supporting evidence regulated by current Spanish Legislation. The product warranty will only be applicable by presenting the proof of purchase (which is the invoice or the receipt) and serial number.

A product is covered under warranty if it presents lack of conformity because it does not correspond to the specified product characteristics, is defective which prevents its normal use according to its purpose, or does not function as described. The purchaser has the right to have the article repaired or replaced (either the product or the faulty component, at the discretion of the manufacturer.)

The warranty is not transferable and won't cover the following issues:

- Attempts of modifications or repairs by an unauthorized service center.

- Unsuitable use
- Incorrect storage
- Explosions or burns caused by incorrect power supplies.
- Other causes not attributable to the manufacturer.

To make a claim, the purchaser must return the product to the store where it was purchased within one month from discovering the fault, and report the nature of the problem, the time and the circumstances under which it occurred.

If the product was purchased through our website, the purchaser must refer to [www.aclamguitars.com](http://www.aclamguitars.com) and complete a RMA (Return to Manufacturer Authorization) form before returning the unit.

We strongly recommend looking at the "Troubleshooting" section of the manual before panicking!!

# Your own settings

Remember here your own settings.

We'd love to hear your settings, so don't forget to share them on social media using our hashtags **#myrigmyrules** **#aclamguitars**

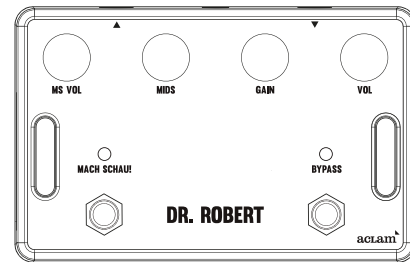
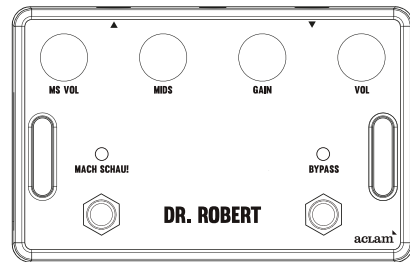
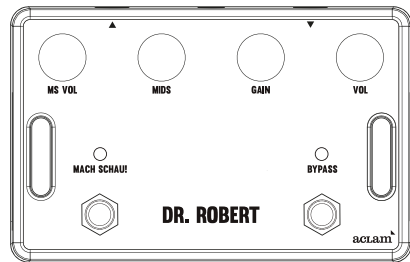
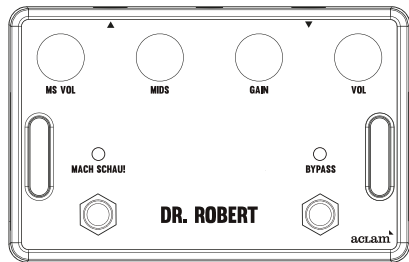



**aclam**<sup>▲</sup>

[www.aclamguitars.com](http://www.aclamguitars.com)